

## MAGNUM MT-16 LED 20W 3000K

OPTICS-S; RAL9007

MAGNUM street light series offers a quick and safe vertical or side entry installation on poles or consoles from  $\varnothing 42$  to  $\varnothing 60$  mm with a standard equipped 3-pole quick IP66/68 connector or a so-called "Fast Connect System" which allows you to connect the luminaire without opening the fixture. Special and diverse optics of installed LED modules ensure that the luminaire corresponds to various lighting demands under different conditions and requirements. The luminaire offers full flexibility for different lighting demands, for it's equipped with the latest LED drivers with multiple dimming and controlling options.



Durable and robust luminaire housing is made out of high pressure die-cast, high quality aluminum, resistant to vandalism and vibrations and with excellent heat dissipation properties. Optional implementations with different LED module configurations with optional CCT (3000 K and 4000 K) and excellent illuminance uniformity.

Powder coated with corrosion resistant, polyester paint. The default color is RAL9007. 5 mm safety tempered glass, easily replaceable.

High-pressure die-cast aluminum spigot for pole/console installation from  $\varnothing 42$  to  $\varnothing 60$  mm, powder coated with polyester, corrosion-resistant paint. Stainless steel washers, nuts and screws. Quick, easy and safe installation. Installation of the luminaire on a pole or a console is secured by two special stainless steel screws. (Allen screws). Wide scope of luminaire applications (technical street lighting, lighting of streets and avenues, orientation and security lighting, industrial lighting, and lighting of parks and car lots).

### PRODUCT DATA

#### General Information

Number of light sources	16 pcs Cree XP-G3
Lamp family name	MAGNUM
Light source color (CCT)	3000 K
Light source replaceable	Yes
Nominal power	20 W
Nominal luminous flux	2620 lm
LED driving current	400 mA
Luminous efficacy	131,0 lm/W
Protection class IEC	Safety class I, S. class II on request
Connecting	IP66/68 3-pole fast connector
Certification	ENEC mark, CE
Light regulation	Prepared for dimming

Optic type outdoor	OPTICS-S
CRI	$\geq 70$
Luminaire fixation bolts	INBUS; M8; 45 mm
Serviceability class	Luminaire is equipped with serviceable parts - (when applicable): LED module, LED driver, optics, front glass cover and mechanical parts.
<b>Light Technical Description</b>	
Tilt angle post-top	0° / 10° / 15°
Tilt angle side entry	0° / 5° / 15°

## PRODUCT DATA

### Operating and Electrical

Input voltage	120...277 V
Input frequency	50 ~ 60 Hz
Power factor $\lambda$	0.95/0.90

### Controls and Dimming

Dimmable	DALI / StepDIM / AstroDIM
----------	---------------------------

### Mechanical and Housing

Housing material	High pressure die-cast aluminum
Optic material	PMMA
Optical cover	Tempered glass (5 mm)
Mounting device	Spigot for diameter 42-60 mm
Fixation type	Post top / side entry
Fixation angle	Mounting angle 0° / 5° / 10° / 15°

### Approval and Application

Ingress protection code	IP66 [Dust protected, jet-proof]
Mech. impact protection	IK09 fixture / IK08 glass
Surge protection	10 kV

### Dimensional Drawing

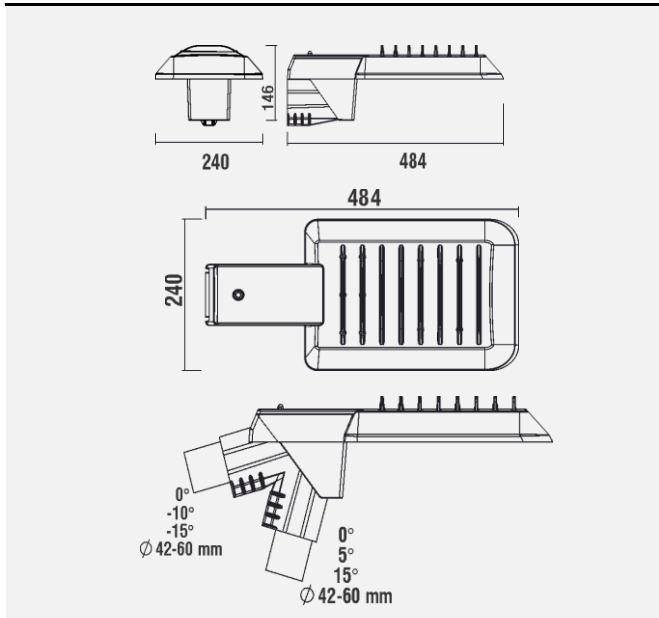

### Over Time Performance (IEC Compliant)

LED useful life L80B10	>100.000 h
------------------------	------------

### Application Conditions

Ambient temp. range	-20 to +45 °C
Average ambient temp.	Ta=35 °C

### Ordering Data

Full order code	2101302000021
Order product name	MAGNUM MT-16 LED 20W 3000K OPTICS-S; RAL9007
Quantity per pack	1
Net weight (piece)	4,6 kg



### Photometric Data

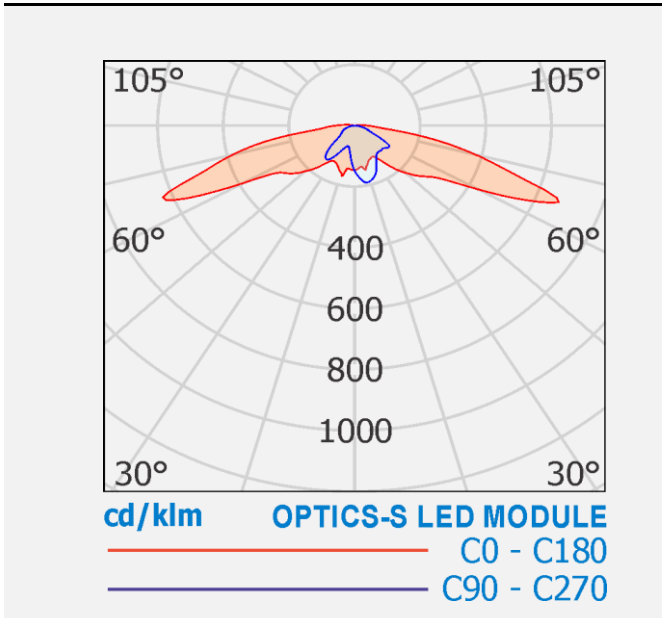

Mines Team d.o.o. Na Logu 14, SI-5220 Tolmin, Slovenia  
<http://www.mt-light.si> | E: info@mt-light.si  
 T: +386 (05) 38 00 345 | +386 (05) 38 00 348