

ICON IC-32 - 48W

OPTICS-A; RAL9007

The ICON series of floodlights were designed mainly for durability and excellent performance. Whether you need to replace a shabby old halogen or high pressure sodium floodlight or just simply want to install a new generation of LED light source, MT-LIGHT's ICON series range offers a perfect solution. Modular design, high efficiency LED engine and intelligent, highly responsive LED drivers are ideal for outdoor sport, industrial, and security lighting. The luminaire is designed to withstand thousands and thousands of operating hours in extreme weather conditions with its advanced thermal and surge protection. The ICON series comes in four sizes with similar design and identical mechanical characteristics.

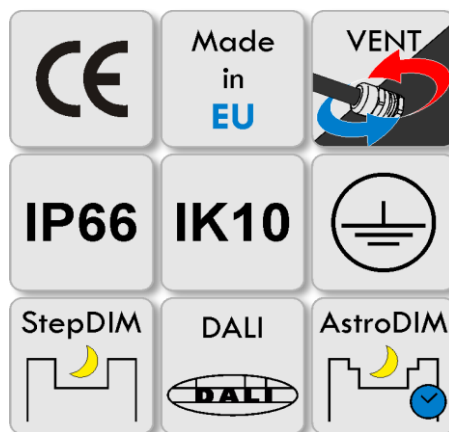

PRODUCT DATA

General information

Number of light sources	32 pcs Cree XP-G3
Lamp family name	ICON
Light source color (CCT)	4000 K
Light source replaceable	Yes
Nominal power	48 W
Nominal luminous flux	6192 lm
LED driving current	500 mA
Luminous efficacy	129 lm/W
Protection class IEC	Safety class I
Connecting	IP66/68 3-pole fast connector
Certification	CE
Light regulation	Prepared for dimming

Optic type outdoor	OPTICS-A
CRI	≥70
Luminaire fixation bolts	Not included
Serviceability class	Luminaire is equipped with serviceable parts - (when applicable): LED module, LED driver, optics, front glass cover and mechanical parts.
Product family name	ICON

PRODUCT DATA

Operating and Electrical

Input Voltage	120...277 V
Input Frequency	50 ~ 60 Hz
Power factor λ	0.95/0.90

Controls and Dimming

Dimmable	DALI / StepDIM / AstroDIM
----------	---------------------------

Mechanical and Housing

Housing Material	High pressure die cast aluminum
Optic material	PMMA
Optical cover	Tempered glass (5 mm)
Mounting device	Steel adapter
Fixation type	Pole/Wall mount
Fixation angle	Mounting angle 0° to 90°

Approval and Application

Ingress protection code	IP66 [Dust protected, jet-proof]
Mech. impact protection	IK10 Fixture / IK08 Glass
Surge Protection	10 kV

Dimensional drawing

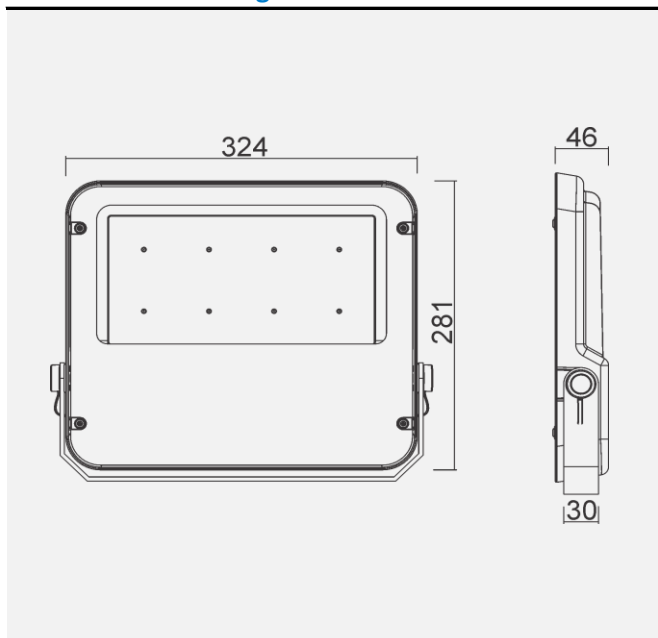

Over Time Performance (IEC Compliant)

LED Useful life L80B10	>100.000 h
------------------------	------------

Application Conditions

Ambient temp. range	-20 to +45 °C
Average ambient temp.	Ta=35 °C

Ordering Data

Full order code	232240484300
Order product name	ICON IC-32 - 48W OPTICS-A; RAL9007
Quantity Per Pack	1
Net Weight (Piece)	3,9 kg

Photometric data

